

# Duetto®

Electric sauna infrared emitter unit

Instructions for installation and use

CE

Made in Finland

## CONTENTS



<b>Delivery includes</b>	3
<b>Technical details</b>	3
<b>Symbol explanations</b>	3
<b>Note before installation</b>	4
Infrared heater controls	
<b>General safety precautions</b>	4-5
<b>The amount and use of infrared heaters</b>	6
The need for infrared heaters	6
Example of installation	6-7
Placing an infrared heater	7
Infrared heaters for stove sauna	7
Joint use of infrared heaters and sauna stove	7
<b>Adjusting the temperature</b>	8
Placing the temperature sensor	8
<b>Ventilation of an infrared sauna</b>	8
<b>Maintenance</b>	8
<b>Installing instructions</b>	9
Installation	9
Installation distances	10
<b>Electric wiring of infrared heaters</b>	11
Shunt	11
Series	11
<b>Guarantee</b>	12
Manufacturer's guarantee	12

## DELIVERY INCLUDES

**(The right for changes is reserved)**

- Infrared heater for stove sauna
- Mounting screws 4 pcs and covering plugs for screws 4 pcs
- Instructions for use, care and installation

## TECHNICAL DETAILS

IR	B/C
Power	900W
Size	K910xL310xP32mm
Glass color	black or grey
Frame	of wood
Wire	3m heat-resistant silicone 2x1, 5mm <sup>2</sup> 
Protection grade	IP 56 protected against dust and water jets
Certificates	
Markings	
Nominal voltage	230V – 240V N1 50Hz
Wave length	6,8 - 7,3 micrometers



## SYMBOL EXPLANATIONS



Prompting symbol "Please read instructions for use, care and installation before installing or using the equipment"



Prohibiting symbol "The device must not be covered"



Duetto® infrared heater for stove sauna is certified  
Infrasauna heater is  marked



Unearthed electric device



Safety instructions



Do not touch the heater while it is switched on. The glass surface is hot and can cause burns.



A broken device must be taken to retailer or recycling centre.



**Read instructions for use, care and installation through in full before starting the installation and keep the instructions for further use.**

## NOTE BEFORE INSTALLATION

### Infrared heater controls

Duetto® -infrared heater can be used in the same space with a regular sauna stove. Please note the included instructions for use, care and installation. When adjusting the temperature, it is recommended to use a separate control unit. Note that the control unit has its own, separate instructions for use, care and installation and take them into account when installing.

Alternatively, you can use a timer instead of the control unit. The timer must have a bipolar cut-out, so the voltage can be cut out.

## GENERAL SAFETY PRECAUTIONS

This appliance can be used by children aged from 8 years and above and persons with reduced physical, sensory or mental capabilities or lack of experience and knowledge if they have been given supervision or instruction concerning use of the appliance in a safe way and understand the hazards involved. Children shall not play with the appliance. Cleaning and user maintenance shall not be made by children without supervision.

One must see a doctor to clarify the individual and health risks affiliated to the use of an infrared heater. Infrared heater must not be used when drunk or under sedative medication. It is recommended that the infrared heater should not be used within 24 hours after sunbathing. If there is any redness/change of color on the skin because of the infrared heater, and it doesn't clear within 24 hours, the infrared heater must not be used again before the change of skin has been medically diagnosed harmless. Children must be supervised that they do not play with the device.



**Note:** The whole back of the infrared heater must be mounted to a solid base. The ventilation in the back of the heater must not be blocked.



**During cleaning the device must be disconnected.**

Before turning the heaters on, make sure they are not covered and that they are in good condition.

**The electric wiring shall only be done by a legitimate electrician or company.**

Specifications given by the electric supplier must be followed (EVU) as well as the appropriate VDE – specifications (DIN VDE 0100).

**INFRARED HEATER MUST NOT BE COVERED!**

Covering it causes a hazard of fire.

**Note danger of life:**

Never carry out repairs yourself. The device shall only be opened at the manufacturing factory.

The device shall only be controlled by a control unit or timer suitable for controlling an infrared heater.

The heater can run continuously up to 6 hours at maximum.



Always make sure that there are no objects on top or close to the infrared heaters before you switch on the heaters.



Check that the infrared heaters have turned off and no longer emit heat after you have finished using the sauna.

The device must be disconnected from the electrical network while installation or repair.

The manufacturer's safety- and installation instructions must be followed.

Take note of the sauna manufacturer's specifications and instructions, too.

**NOTE!**

Dear Customer

We want to emphasize already, that in the case of any warranty claims an inspection log sheet / a copy of a bill of the Electricity Company or electrician who carried out the work must be provided.

**During cleaning the device must be disconnected.**

Before turning the heaters on, make sure they are not covered and that they are in good condition.

## THE QUANTITY AND USE OF INFRARED HEATERS

The heat that Duetto® -infrared heaters produce, makes you feel good. Placing the infrared heater close to the bigger muscles of the body gives a maximum benefit of the heaters.

One infrared heater/person requires about 50cm space of the bench width all around it. The heaters are placed on the wall mounting them behind the back(s) of the bather(s) and on both sides of the bench. The heater for the legroom is installed in line with the bench under the seat mounting it onto the back wall. In front of the infrared heaters will be installed grills for leaning, on which you can lean on during sauna. Legroom heater doesn't need a grill. Take note of the security and installation instructions provided by the manufacturer while installing the infrared heaters.

A pleasant temperature for an infrared sauna is 60°C. Every bather will find a suitable temperature for themselves by trying.

A good time to bathe in an infrared sauna is 30 minutes. Maximum sauna time is one hour at once.

*Infrared sauna evaporates a lot of water from your body. Remember to drink plenty of water.*

### The need for infrared heaters

When determining the quantity of infrared heaters the sauna space must be taken into account. You need about 1kW / m worth of power altogether from the heaters to heat up the space<sup>3</sup>. Any glass or tiled surface adds about 1,2kW/m to the need of power<sup>2</sup>.

### Installation examples

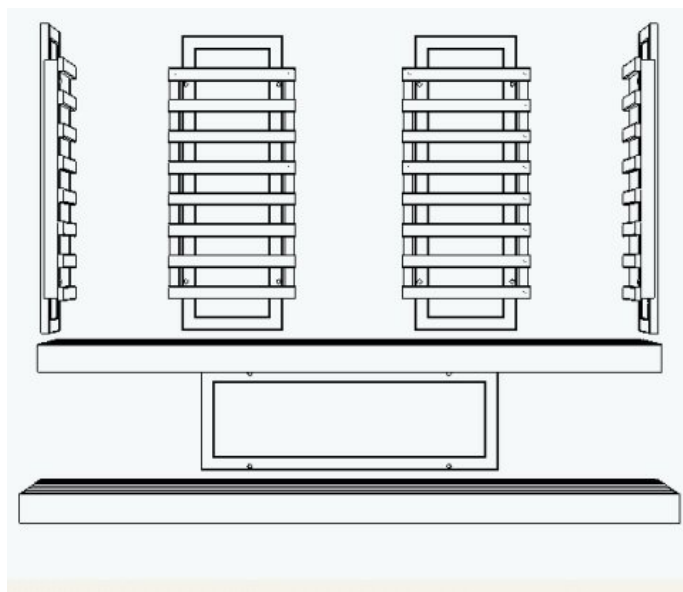

When the sauna size is about 4m<sup>3</sup> and you want to heat it up with Duetto® -infrared heater alone, five heaters is enough.

Infrared heaters are placed on the back wall behind the bench on the sides legroom

Leaning grills are installed to cover the heaters.  
Legroom heater is installed underneath the upper bench so, that it is mounted on the wall without a leaning grill.

The height of an infrared sauna room should be no less than 1800 mm.

### Infrared heater in a ceiling

In an infrared room, a heater can also be mounted to the ceiling if required, so that the ray of heat is directed to the legs of seated people.

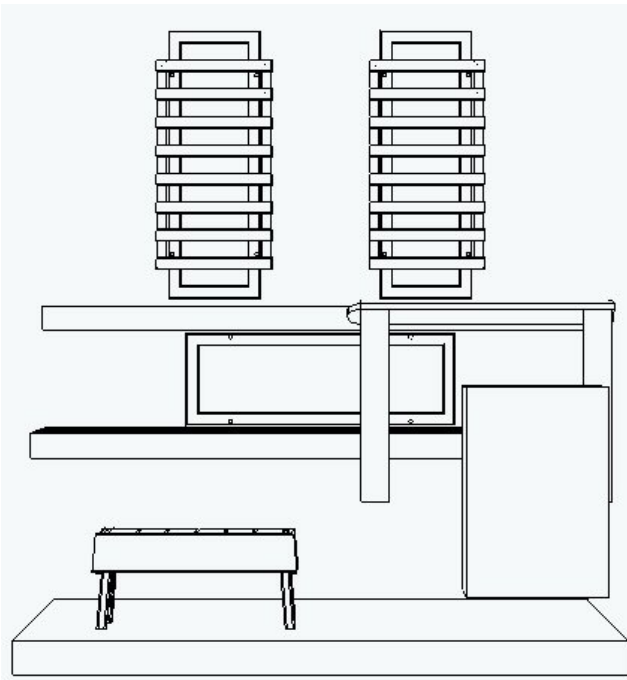

In a stove-heated sauna, the distance between a heater and sauna ceiling should be no less than 100 mm.

In a stove-heated sauna you need three heaters for two bathers, for example, when using the regular stove at the same time. One for the back of each bather covered with a leaning grill and one heater for the legroom. Legroom heater is mounted underneath the upper bench, on the back wall. Legroom heater doesn't need a grill.

The height of a sauna room is normally between 2100 to 2300 mm. The minimum height is specified in the installation and operating instructions of the sauna stove.

Using infrared heaters in the ceiling of a stove-heated sauna is not recommended.

### **Placing the infrared heater**

The heaters are placed on the wall mounting them behind the back(s) of the bather(s) and on both sides of the bench. The heater for the legroom is installed in line with the bench under the seat mounting it onto the back wall.

In front of the infrared heaters will be installed grills for leaning, on which you can lean on during sauna. Legroom heater doesn't need a grill.

### **Infrared heater for stove sauna**

If you want, you can heat a stove sauna with infrared heaters. In this situation the need for heaters is calculated by the cubic capacity of the sauna.

When the sauna is heated with a stove you need a minimum of one infrared heater per bather. To enhance the effect of the heat you can install infrared heaters to the legroom and on the sides of the benches when possible. Preheat the sauna with the stove to approx. 45°C. Turn on the infrared heaters and enjoy the beneficent heat.

### **Joint use of infrared heaters and sauna stove**

The heaters are placed on the wall mounting them behind the back(s) of the bather(s) and on both sides of the bench and to the legroom. The heater for the legroom is installed in line with the bench under the seat mounting it onto the back wall.

In front of the infrared heaters will be installed grills for leaning, on which you can lean on during sauna. Legroom heater doesn't need a grill.

Take note of the security distances of the stove when installing the infrared heaters.

A pleasant temperature for a combination sauna is 70°C. Every bather will find a suitable temperature for themselves by trying. In a combination sauna you can throw water on the stove and enjoy the infrared heat simultaneously.

*Infrared sauna evaporates a lot of water from your body. Remember to drink water.*

## ADJUSTING THE TEMPERATURE

The temperature in the infrared sauna is adjusted with a control unit or timer suitable for controlling infrared heaters. Follow the control unit or timer manufacturer's instructions for installation and use.

The timer must have a bipolar cut-out, so the voltage can be cut out.

### Placing the temperature sensor

When you use a control unit to control the temperature in an infrared sauna the manufacturer's instructions for installation and use must be followed.

If you use a timer that defines how long the heaters are on you do not need a temperature sensor.

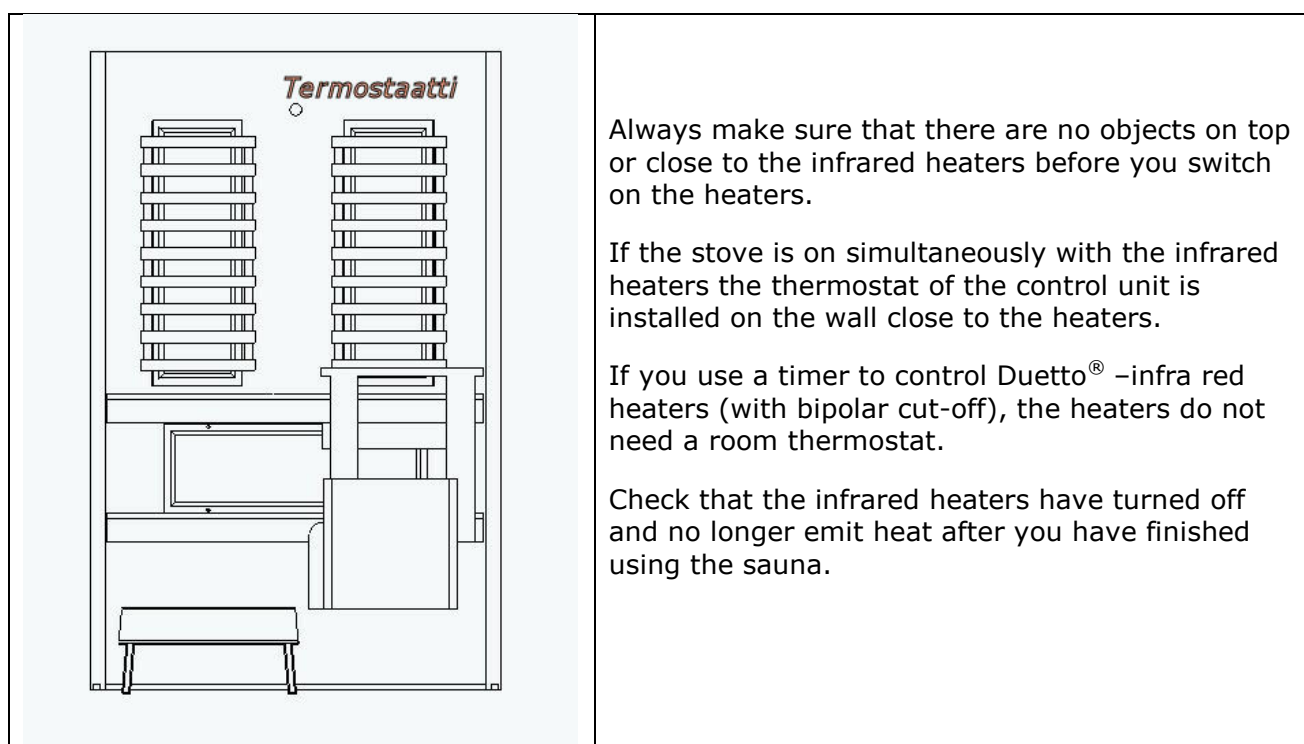

Always make sure that there are no objects on top or close to the infrared heaters before you switch on the heaters.

If the stove is on simultaneously with the infrared heaters the thermostat of the control unit is installed on the wall close to the heaters.

If you use a timer to control Duetto® -infra red heaters (with bipolar cut-off), the heaters do not need a room thermostat.

Check that the infrared heaters have turned off and no longer emit heat after you have finished using the sauna.

*The electric wiring shall be carried out by a legitimate electrician or a company following the appropriate specifications of the electricity trade.*

## VENTILATION OF AN INFRARED SAUNA

You must take care of sufficient ventilation when using infrared heaters to get enough fresh air into the room. When the infrared heaters stay hot they provide nice warmth during the whole sauna session.

## MAINTENANCE

Duetto® - infrared heater doesn't require any other maintenance apart from cleansing. The cleaning can be carried out with a cloth and mild detergent.



### **During cleaning the device must be disconnected.**

Before turning the heaters on, make sure they are not covered and that they are in good condition.



## INSTALLING INSTRUCTIONS

Check the product in case of any damages from the transport.  
 Attach the infrared heater following the instructions. Pay attention to installing the screws, covering plugs and casing the visible parts of the silicone cable.  
 Perform the electric installations. The electric wiring shall be carried out by a legitimate electrician or a company only following the appropriate specifications of the electricity trade.  
 Make sure that the infrared heater is functioning normally and securely.  
 Install the leaning grill.  
 If the infrared heater is damaged it shall not be installed or used.

### INSTALLATION of the **infrared heater**

Attach the heater onto a straight, solid platform that is at least the same size as the heater.

The heater is mounted with four screws and the screws are covered with plugs.

Don't tighten the screws too much. The infrared heater is made of glass and breaks when bended.

The ventilation in the back of the heater must not be blocked. Infrared heater must not be covered.

The legroom heater is placed underneath the upper bench and mounted to the back wall.

The joint box is installed under the benches or in a place otherwise suitable.

The wires of the infrared heater are joined either in shunt or in series if needed (a maximum of 2 infrared heaters in one series).

A cable from the control unit is brought to the connection box. The connections should be carried out following the electric installation instructions of the control unit.

The temperature sensor is installed on the wall near the heaters if it is a stove-heated sauna. In other case the sensor is installed on the ceiling of the infrared sauna about 20cm from the wall where the heaters are on.

A timer does not need a temperature sensor for the room.

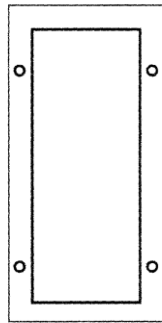

The gaps in the leaning grill must be at least so big that a ball of a diameter of 75mm will not touch the surface of the glass.

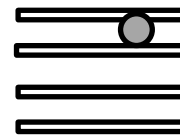

The distance between the horizontal bars of the backrest to the surface of the heater frame must be at least 9 mm.

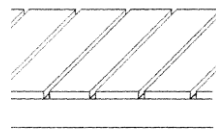

**IP54**

IP54 Protected against dust and water jets

The cord of the heater is placed downwards and stringed behind the panel or covered otherwise.



Control unit or timer switch

**Installation distances**

Infrared heater can be mounted onto a wooden surface directly from its back and edges.

The safety distance between hot front part of the infrared heater and flammable material is 5mm

Infrared heater must not be covered.

The ventilation in the back of the heater must not be blocked.

Area without heat elements 20 mm  
in each corner

Infrared heater  
glass edge temperature max 80°C



Do not touch the heater while it is  
switched on. The glass is hot and  
can cause burns.

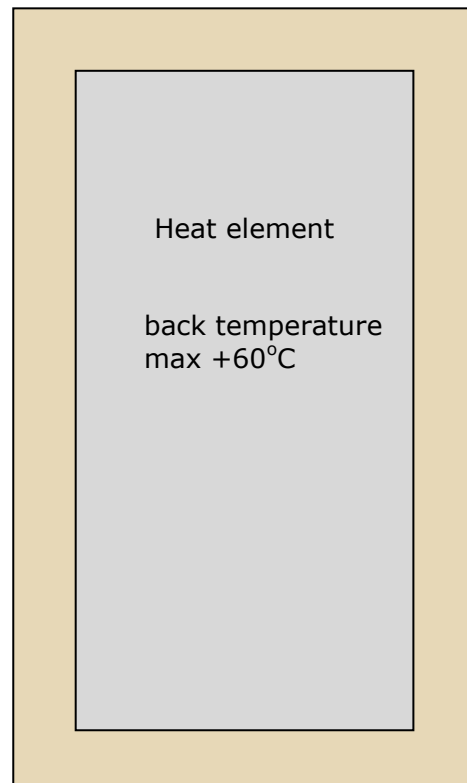

## ELECTRIC WIRING OF INFRARED HEATERS

When performing the electric wiring the infrared heaters can be connected in two different ways - either shunt or series.

### Shunt

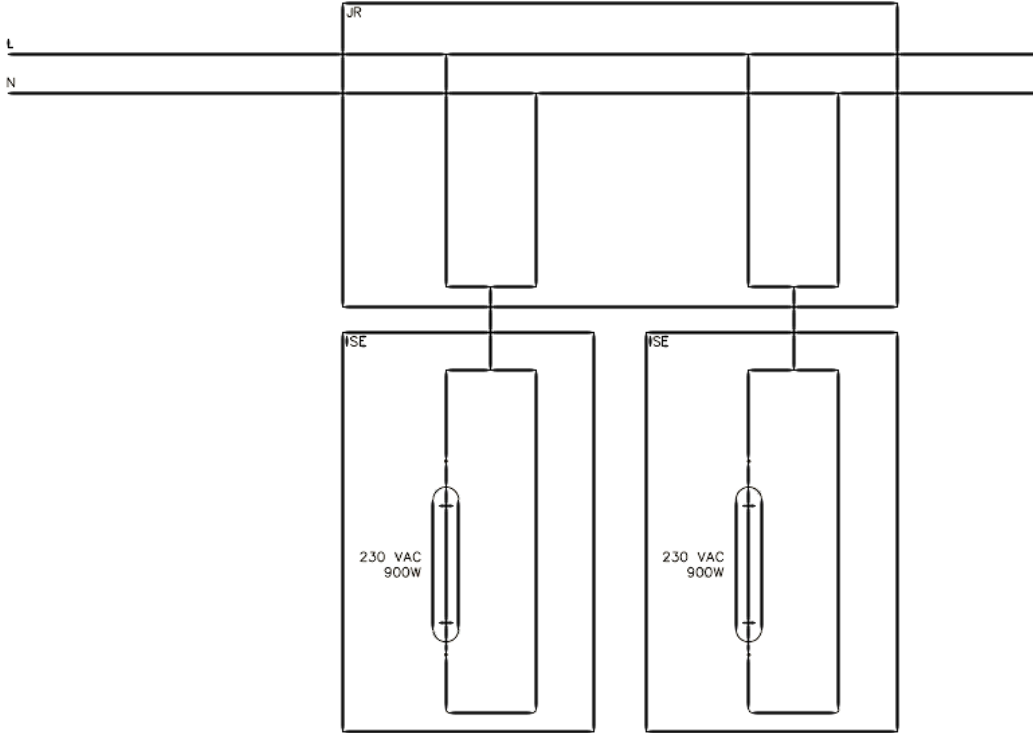

### Series

If two heaters are connected in series the fuse size needed is reduced.

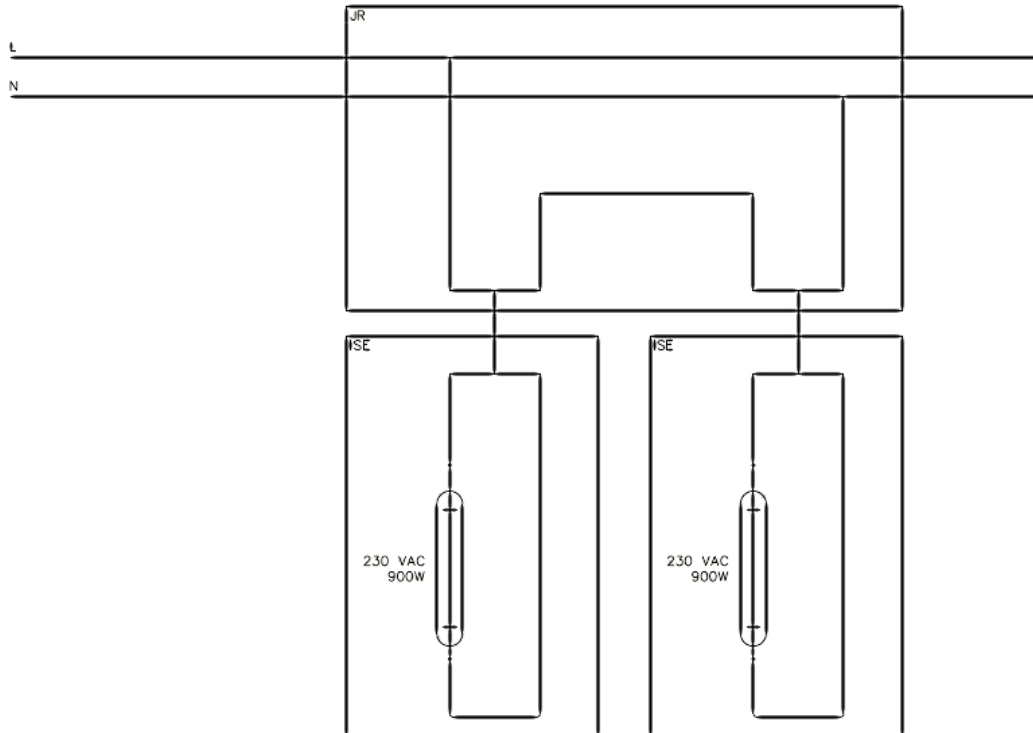

## WARRANTY

The warranty is consistent with currently existing specifications.

### **Manufacturer's guarantee**

This warranty clause is followed between Rauduspuu Oy (later "Manufacturer") and the other party (later "Client") considering the products provided by the Manufacturer, unless otherwise specifically agreed in writing in the agreement. This warranty clause supersedes all the general terms used by the client considering the matters regulated in this warranty clause. The warranty only applies on products sold and used in Finland.

The Manufacturer guarantees, that the product matches the specifications agreed and is suitable for its ordinary use. The warranty covers possible defects of production and material. The Manufacturer is not responsible for defects that are due to normal tear and wear or due to the character qualities of the wooden parts.

The guarantee is valid for 12 months when used commercially and 24 months in private use. Guarantee time starts when the product has been delivered to the final user. The Manufacturer is not, however, in any way responsible for defects that appear over two (2) years after delivering the product to the Client. The warranty receipt is the receipt from the retailer or a report from a legitimate electrician/company/measurement report.

The buyer must take care of the product carefully. When receiving the product, the buyer must make sure it has no defects due to transportation or storing. The Manufacturer is not responsible for product defects, malfunctions or deficiencies that are caused by transportation or false storing, installation or use against the manufacturer's instructions or using in a space where the conditions do not comply the manufacturers recommendations.

If the device is altered or the instructions of use provided by the manufacturer are not followed without manufacturer's distinct approval, any warranty is invalid.

The manufacturer can choose to fix a defected product or deliver a new product to the client to replace the defected one. The warranty does not cover possible detaching and installation costs or other similar costs. A broken product must be returned on manufacturer's request and cargo cost.

When making any warranty claims both the serial number and the type number must be provided along with a probative error description.

The buyer should notify about any defect or malfunction immediately after it has been detected. The notice can be delivered primarily to the retailer of the product, authorised installation company or importer.

The manufacturer is not in any conditions responsible for indirect losses such as loss of productivity, business profit, contracts, benefit of use or decrease in revenue.

These terms are valid for the time being since 1.4.2019.

Selling date:

Manufacturer:  
Rauduspuu Oy  
Muurimestarintie 6  
61800 Kauhajoki

Retailers stamp and signature